



WALRUS

TPH Series

MULTISTAGE CENTRIFUGAL PUMP

Instruction Manual

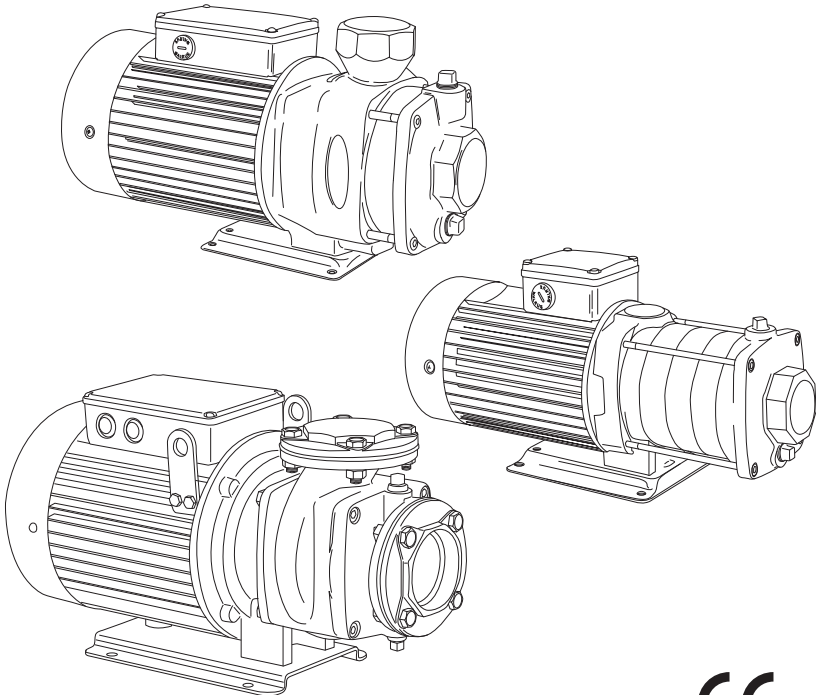

ISO 9001 Certified

WALRUS PUMP CO., LTD.

EC Declaration of Conformity

Manufacturer:

Walrus Pump Co., Ltd.

Address:

No.83-14, Dapiantou, Sanzhi Dist., New Taipei City 252, Taiwan

Declare that the machinery described:

Name : Water Pump

Model : TPH Series

Conform to the following directive:

2006/42/EC—Machinery directive

2006/95/EC—Low voltage directive

2004/108/EC—EMC (Electromagnetic compatibility) directive

Refer to the following standards:

EN ISO 12100:2010

EN ISO 13857:2008

EN 809:1998+A1:2009

EN 60204-1:2006

EN 60335-1:2012

EN 60335-2-41:2003

EN 61000-6-2:2005

EN 61000-6-3:2007

R&D department manager: Kao Tien-chuan

Manager:

Kao Tien chuan

TPH Instruction Manual

Please study all instructions carefully before installing your new system, as failures caused by incorrect installation and operation are not covered by the warranty.

1. General Data:

1.1 Applications

The TPH Series are modernly designed with quiet and high efficient operation pumps, suitable for dependable water transfer, circulating or booster service. It works for clean or other liquids without abrasive matters.

- Industrial circulation system
- Washing/cleaning system
- Pressure boosting system
- Water/liquid transfer
- Agricultural irrigation
- Air-conditioning

1.2 Pump Construction:

Horizontal multi-stage centrifugal pump, non self-priming, co-axial pump/motor design, impellers mounted on extended motor shaft. All parts in contact with the pumped liquid are made of stainless steel.

1.3 Operation conditions:

1. Ambient temperature: Max. 40°C
2. Liquid temperature range: 0°C to 90°C
3. Operating pressure: Max. 10 kg/cm²
4. Inlet pressure: Max. 6 kg/cm²
5. Head: 50Hz : Up to 70M
60Hz : Up to 80M

1.4 Applications

TPH pumps are horizontal, multistage centrifugal pumps for the pumping of clean, thin and non-explosive liquids, not containing solid particles or fibres that may attack the pump mechanically or chemically.

The pump must not be used for the transfer of flammable or toxic liquids.

2. Installation and piping

2.1 Installation site

- 2.1.1 For secure operation, please mount and bolt the pump base to the foundation.
- 2.1.2 Select a dry and good ventilated site and provide accessible space around the pump for future maintenance and service.
- 2.1.3 Make sure the ambient temperature is below 40°C(104°F) and the flowing liquid temperature does not exceed 90°C(194°F) .
- 2.1.4 Do not operate the pump under explosive environment.
- 2.1.5 Horizontal installation is recommended. When it is installed in other positions, please

provide drain holes to allow drainage of the pump.

- 2.1.6 Indoor: TO avoid your furniture damage, do not install the pump on ceiling, carpet or any place close to electrical appliance, and also must provide drain hole.
- 2.1.7 Outdoor: When the pump is installed outside, please provide a suitable cover to protect it from weather and frost. Please do not allow any foreign objects fall into the motor fan cover.

2.2 Electrical connection

- 2.2.1  This mark located outside the connection box is a warning for an electrical hazard.

2.2.2 The electrical connection should be carried out in accordance with local regulations. The operating voltage and frequency are marked on the nameplate. Please make sure that these data match with your job requirement. For your safety, be sure the Residual current device (RCD, 30mA) is in your system and grounding is properly connected to prevent from electric shock.

2.2.3 Motors must be connected to a motor-protective circuit breaker which can be manually reset. Set the motor-protective circuit breaker according to the rated current of the motor. See nameplate.

2.2.4 Three phase motors must be connected to a motor starter for protection of overload and single phase running. Please be sure if the direction of rotation is correct. For three phase motor you can reverse the direction of rotation by interchanging any two of the incoming supply wires. Before your first operation, please place a allen wrench against the shaft at motor end and turn by the direction of rotation to see if rotor spins freely.

2.2.5 The position of the connection box is adjustable. It can be turned either side before the pump is installed. The preset position from the factory is on the top of the motor. To change the position of the connection box, please remove the bolts on the motor frame (4 bolts which are bolted into the chamber) and turn the stator housing to the required position. Replace the screws and tighten securely.

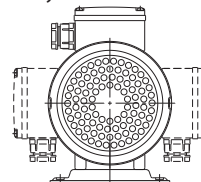

Fig.1

- 2.3 The pump should be installed so that the suction pipe is as short and the suction lift as small as possible.
- 2.4 When draw liquid from the same level of the pump suction inlet, please allow a downward slope from the liquid source to the pump suction inlet to avoid air sucked in. If it is to pump liquid from a level lower than the pump suction inlet, a foot valve must be fitted to the end of the suction pipe.
- 2.5 Please select the pipe size specified in the specifications. Smaller piping will cause considerable pressure loss and affect pump efficiency.
- 2.6 All piping joints must be completely tight. Leakage in suction piping may result in the loss of the suction capability. Leakage in discharge piping may cause the "cycling" of the pump.
- 2.7 Please do not allow any foreign objects (chewing gum, dirt, and sand etc.) fall into the pump or motor.
- 2.8 The pump lifting capacity is related to the temperature of flowing liquid. Under normal flowing temperature (20°C - 30°C), it will lift up to 5M. At high temperature operation (over 60°C), the pump must be installed at the level lower than the liquid source or the pump inlet pressure must be higher than 1 atmosphere (15 PSI).
- 2.9 It is extremely dangerous to run the pump against a closed discharge valve, because it will cause extremely high liquid flow temperature and damage your pump. You may connect a bypass/a drain to the discharge pipe to allow a minimum liquid flow through the pump.
- 2.10 Metal piping is recommended when the operations require high lifting head or high liquid temperature.
- 2.11 In systems with hot liquids (over 60°C), extra caution should be exercised to prevent from personal injury caused by escaping water.

3. Operation instructions

3.1 Priming

Do not start the pump until it has been primed.

Follow the following priming instruction:

- 3.1.1 Booster systems and systems where the liquid level on the suction side is above the pump inlet:
 - 3.1.1.1 Close the isolating valves either side of the pump.
 - 3.1.1.2 Remove the priming plug, fig. 2.

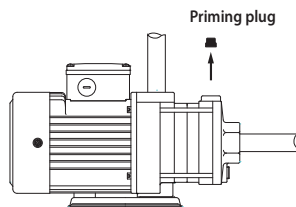

Fig.2

- 3.1.1.3 Slowly open the suction valve and keep it open until a steady stream of liquid runs out the priming port.
- 3.1.1.4 Replace the priming plug and tighten it.
- 3.1.2 Pumping from tanks and wells where the liquid level on the suction side is below the pump inlet:
 - 3.1.2.1 Close the discharge isolating valve.
 - 3.1.2.2 Remove the priming plug, fig. 3.

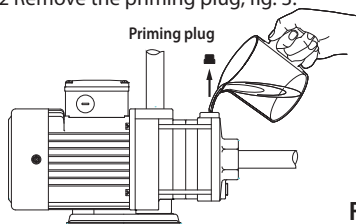

Fig.3

- 3.1.2.3 Pour water through the priming port. Make sure that the suction pipe and pump are completely filled with liquid and vented.
- 3.1.2.4 Replace the priming plug and tighten it.
- 3.2 Start the pump and slowly open the discharge valve until it is fully open.
- 3.3 If there is no discharge flow after a few minutes, please turn off the pump and repeat the Process of 3.1 Turn the pump on and off several times until it is working normally.
- 3.4 When pump is working on normal condition, measure the motor current and check it with the nameplate value. If it exceeds the rated value, please reduce the lifting capacity or fully open the valve.
- 3.5 When pump is not in use for a period, it should be drained by removing the priming and drain plugs. For start up after long time inactivity, please check if the impeller and mechanical seal are free. If they are locked up by sand, rust or something else please clean them up.

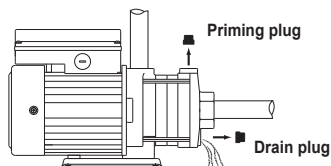

Fig.4

4. Noise level

Model	\overline{LA} dB(A)		Model	\overline{LA} dB(A)		Model	\overline{LA} dB(A)	
	50Hz	60Hz		50Hz	60Hz		50Hz	60Hz
TPH 2T2K	<70	<70	TPH8T2K	<70	<70	TPH25T2KF	76	78
TPH2T3K	<70	<70	TPH8T2.5K	-	<70	TPH25T3KF	76	78
TPH2T4K	<70	<70	TPH8T3K	<70	<70	TPH25T4KF	76	78
TPH2T5K	<70	<70	TPH8T4K	<70	71	TPH25T5KF	76	78
TPH2T6K	<70	<70	TPH8T5K	<70	71	TPH25T6KF	-	78
			TPH8T6K	<70	-			
TPH4T2K	<70	<70	TPH12T1K	-	<70	TPH50T2KF	78	-
TPH4T3K	<70	<70	TPH12T2K	<70	<70	TPH50T2.5KF	-	78
TPH4T4K	<70	<70	TPH12T3K	<70	72	TPH50T3KF	78	-
TPH4T5K	<70	<70	TPH12T4K	<70	77	TPH50T4KF	78	78
TPH4T6K	<70	<70	TPH12T5K	71	-	TPH50T5KF	-	78
			TPH12T6K	71	-			

The uncertainty is 4dB(A).

5. Maintenance

5.1. Lubrication

The mechanical seal and shaft sleeves are lubricated by the pumped liquid.

5.2. Periodic checks

The following checks should be carried out periodically to ensure the normal operation.

5.2.1. Check the quantity of liquid and operating pressure.

5.2.2. Check there are no leaks on piping joints.

5.2.3. Check the tripping of the motor starter.

5.2.4. Check that all controls are functioned normally.

5.3. The pump must not be used to transfer explosive liquids. In systems with hot liquids (over 60°C), extra caution should be exercised to prevent from personal injury.

5.4. The pump should not be used to transfer toxic or contaminated liquids. Please carefully follow all instructions in the manual as Walrus may refuse to accept the contaminated pump for servicing.

5.5. If the supply cord is damaged, it must be replaced by a special cord or assembly available from the manufacturer or its service agent.

6. Wiring diagram

6.1 Single Phase

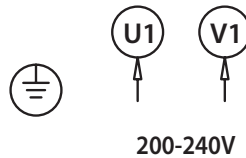

6.2 Three Phase

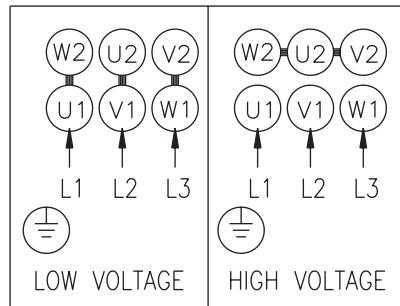

7. Fault finding

(Make sure to disconnect the power before attempting to diagnose any fault.)

Fault	Cause
1. Pump does not start	1. Check if electrical power source, fuse or circuit breaker failed.
	2. Check if pump is locked up by sand, rust or any foreign objects.
	3. Check if the motor is defective due to overload or other causes.
2. Pump runs at reduced capacity or no discharge water	1. If it is a three phase motor, please check if the direction of rotation is correct.
	2. Check if the inlet source is sufficient, the suction lift is not too great and the temperature is within the normal range.
	3. Check if there is any leakage in suction pipe, check valve works normal and mechanical seal is not defective etc.
3. Pump stops during operation	1. Motor overheat due to excessive suction lift or too high liquid temperature.
	2. Control circuit has cut out (pressure switch or level controller).

8. Dimensions (mm)

TPH 2/4

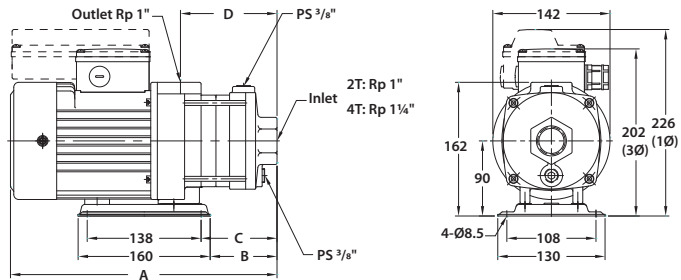

TPH 2T

Model	A	B	C	D
TPH 2T 1K	305	63	74	99
TPH 2T 2K	305	63	74	99
TPH 2T 3K	323	81	92	117
TPH 2T 4K	341	99	110	135
TPH 2T 5K	399	117	128	153
TPH 2T 6K	417	135	146	171

TPH 4T

Model	A	B	C	D
TPH 4T 2K	315	73	84	109
TPH 4T 3K	381	99	110	135
TPH 4T 4K	408	126	137	162
TPH 4T 5K	435	153	164	189
TPH 4T 6K	493	181	192	217

TPH 8/12

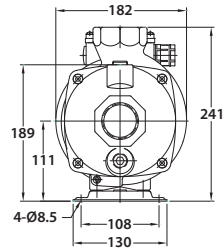
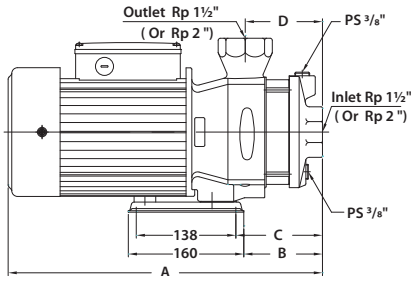

TPH 8T

Model	A	B	C	D
TPH 8T 2K	375	77	88	75
TPH 8T 2.5K	407	109	120	107
TPH 8T 3K	407	109	120	107
TPH 8T 4K	435	109	120	107
TPH 8T 5K	473	143	154	141
TPH 8T 6K	473	143	154	141

TPH 12T

Model	A	B	C	D
TPH 12T 1K	335	77	88	75
TPH 12T 2K	375	77	88	75
TPH 12T 3K	435	109	120	107
TPH 12T 4K	435	109	120	107
TPH 12T 5K	473	143	154	141
TPH 12T 6K	473	143	154	141

TPH 25T

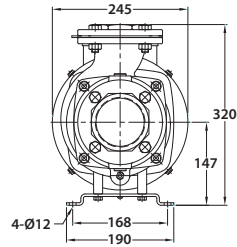
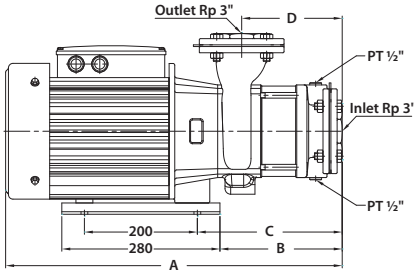

TPH 25T 50Hz

Model	A	B	C	D
TPH 25T 2KF	596	216.5	256.5	180
TPH 25T 3KF	656	276.5	316.5	240
TPH 25T 4KF	656	276.5	316.5	240
TPH 25T 5KF	766	336.5	376.5	300

TPH 25T 60Hz

Model	A	B	C	D
TPH 25T 2KF	536	156.5	196.5	120
TPH 25T 3KF	596	216.5	256.5	180
TPH 25T 4KF	596	216.5	256.5	180
TPH 25T 5KF	706	276.5	316.5	240
TPH 25T 6KF	706	276.5	316.5	240

TPH 50T

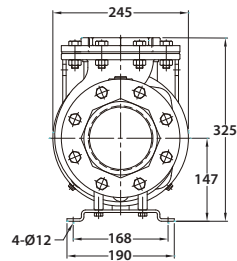
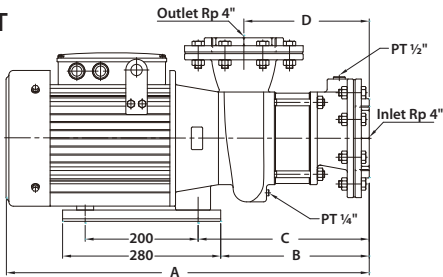

TPH 50T 50Hz

Model	A	B	C	D
TPH 50T 2KF	642.5	263	303	222
TPH 50T 3KF	752.5	323	363	282
TPH 50T 4KF	802.5	323	363	282

TPH 50T 60Hz

Model	A	B	C	D
TPH 50T2.5KF	582.5	203	243	162
TPH 50T 4KF	692.5	263	303	222
TPH 50T 5KF	742.5	263	303	222

Limited Warranty

Products manufactured by Walrus Pumps Co (Walrus) are warranted to the first user only to be free of defects in material and workmanship for a period of 12 months from date of installation, but no more than 24 months from date of shipment. Walrus' liability under this warranty shall be limited to repairing or replacing at our election, without charge, FOB Walrus' distribution center or authorized service agent. Walrus will not be liable for any cost of removal, installation, transportation or any other charges that may arise in connection with warranty claim.

The warranty period commences on the date of original purchase of the equipment. Proof of purchase and installation date, failure date, and supporting installation data must be provided when claiming repairs under warranty.

This warranty is subject to due compliance by the original purchaser with all directions and conditions set out in the installation and operating instructions. Failure to comply with these instructions, damage or breakdown caused by fair wear and tear, negligence, misuse, incorrect installation, inappropriate chemicals or additives in the water, inadequate protection against freezing, rain or other adverse weather conditions, corrosive or abrasive water, lightning or high voltage spikes or through unauthorized persons attempting repairs are not covered under warranty.

Walrus will not be liable for any incidental or consequential damages, losses, or expenses, arising from installation, use, or any other causes. There are no express or implied warranties, including merchantability or fitness for a particular purpose, which extend beyond those warranties described or referred to above.

Certain states do not permit the exclusion or limitation of incidental or consequential damages or the placing of limitations on the duration of an implied warranty, therefore, the limitations or exclusions herein may not apply. This warranty sets forth specific legal rights and obligations, however, additional rights may exist, which may vary from state to state.

Supersedes all previous publications



WALRUS PUMP CO., LTD.

Web: www.walruspump.com