

TPH Series

Multi-stage Centrifugal Pump



WALRUS
WALRUS PUMP CO., LTD.

Contents

General Data	2
Performance Range	3
Sectional Drawing	4
Performance Curves/Technical Data	
TPH 2T	5
TPH 4T	7
TPH 8T	9
TPH 12T	11
TPH 25T	13
TPH 50T	15

TPH Series Multistage Centrifugal Pump



50Hz

Power: 0.42 - 11.6 kW

Head: Up to 70M

Flow: Up to 1200 L/min

60Hz

Power: 0.37 - 14.2 kW

Head: Up to 80M

Flow: Up to 1400 L/min

Outlet: 1" - 4"

Inlet: 1" - 4"

Applications

The TPH Series is horizontal multistage centrifugal pump, suitable for clean water/liquid without abrasive matters. The applications are versatile, such as pressure boosting, transfer, circulation, and machinery.

- Industrial circulation system
- Washing/cleaning system
- Pressure booster system
- Water/liquid transfer
- Agricultural irrigation

Standard Mode

	TPH	4T	2K	S	F	A	H	CH
Model type								
Nominal flow rate (m ³ /hr)								
Nominal head (kg/cm ²)								
Code								
Standard mode								
N: SUS 316 (2T/4T/25T/50T)								
S: SUS 304 (2T/4T/8T/12T)								
Flange type (25T/50T)								
Air conditioning (IP 44)								
Insulation class: H.								
Insulation class: H. (2T/4T)								
Mechanical seal type: HGSV (Carbon + SiC + Viton)								
Water temperature : +4°C ~ +120°C								
Oil temperature : +0°C ~ +150°C								

Operating Conditions

1. Ambient temperature: Max. +40°C
2. Liquid temperature range: +0°C ~ +90°C
3. Operating pressure: Max. 10 kg/cm²
4. Inlet pressure: Max. 6 kg/cm²

Pump Construction

Horizontal multistage centrifugal pump, non self-priming, co-axial pump/motor design, impellers mounted on extended motor shaft. Main working parts made by stainless steel.

Motor

Enclosure protection class: IP54

Insulation class: F.

Frequency range: 50 / 60 Hz

Nominal speed : 2900 / 3500 rpm

Voltages code:

Code	PH	50Hz	60Hz
61B	1	-	220V
51R	1	200-240V	-
53Q	3	200-240/380-440V	-
A3Z*	3	200-255/380-440V	200-255/380-480V
A3U*	3	200-240/380-415V	200-240/380-440V
63Q	3	-	200-240/380-440V
63Z	3	-	200-255/380-480V

Optional : 50Hz, 60Hz models are available on request.

* The motor can be use in both 50/60 Hz.

TPH Series Multistage Centrifugal Pump

Performance curve (50Hz)

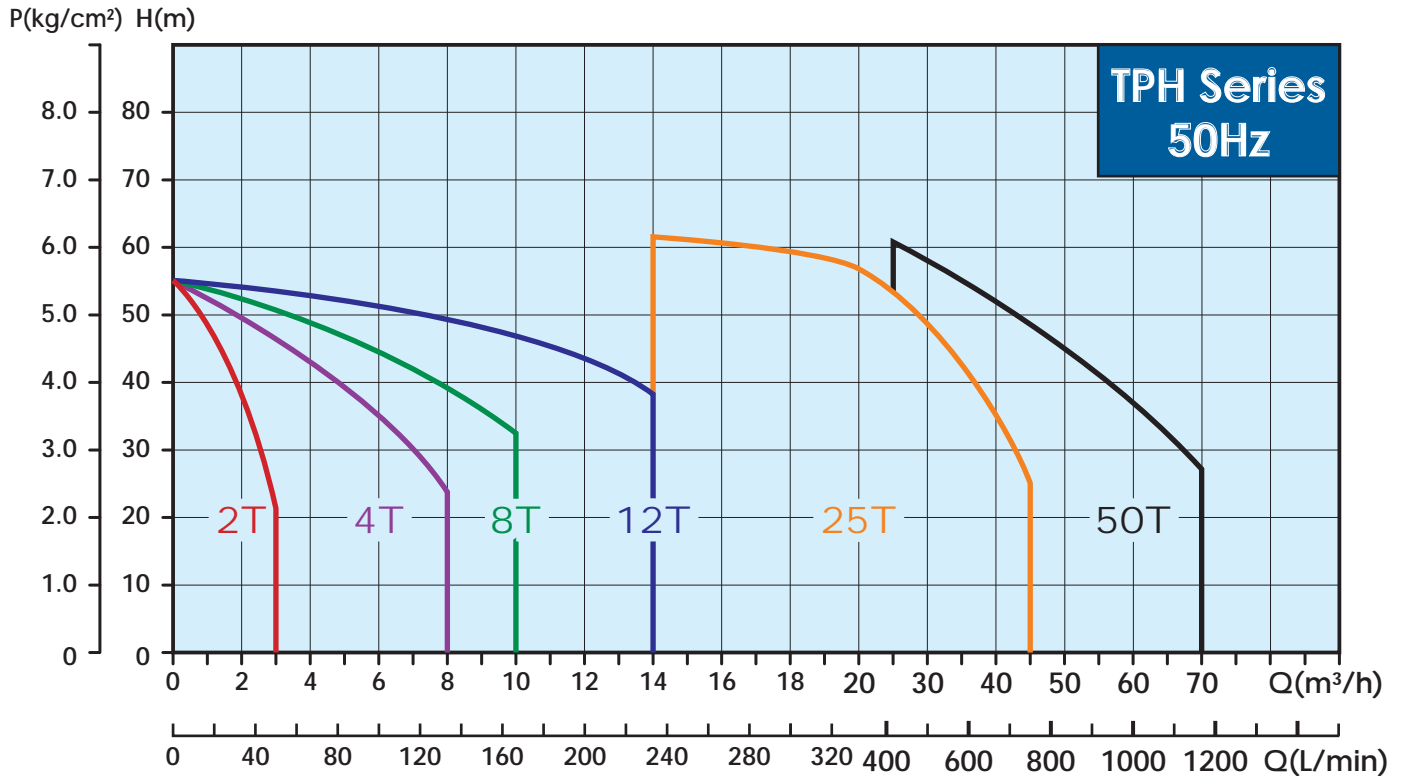

Performance curve (60Hz)

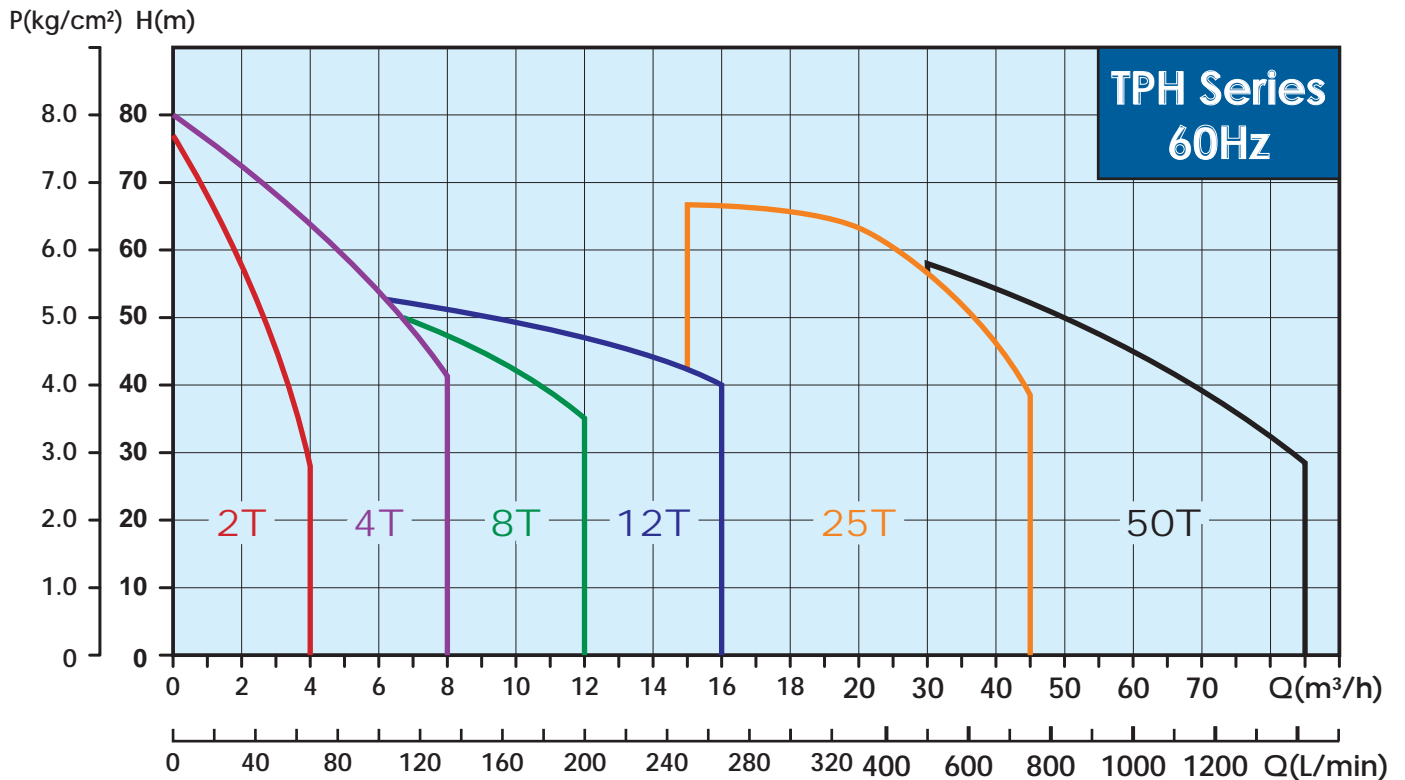

Sectional drawing

(TPH2/4T)

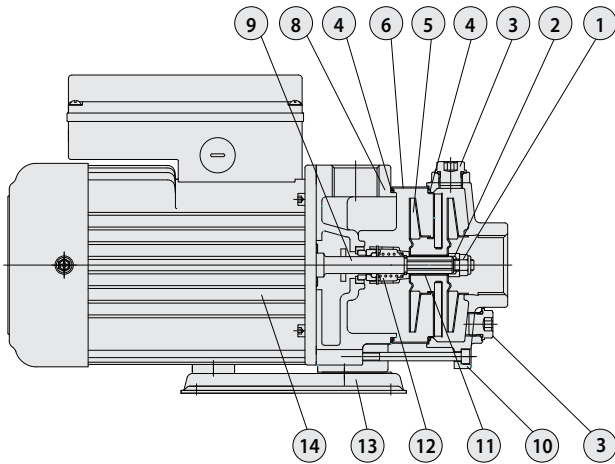

(TPH 8/12T)

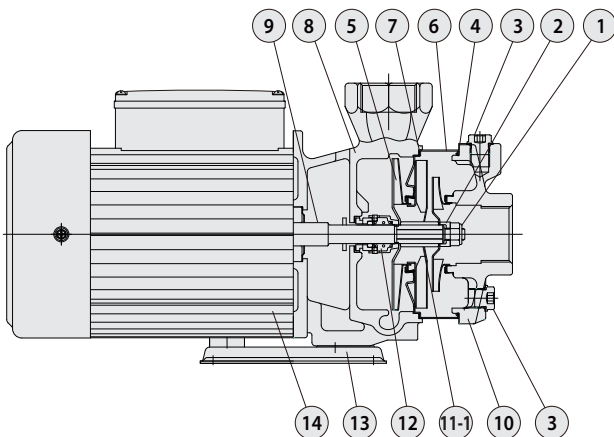

(TPH 25/50T)

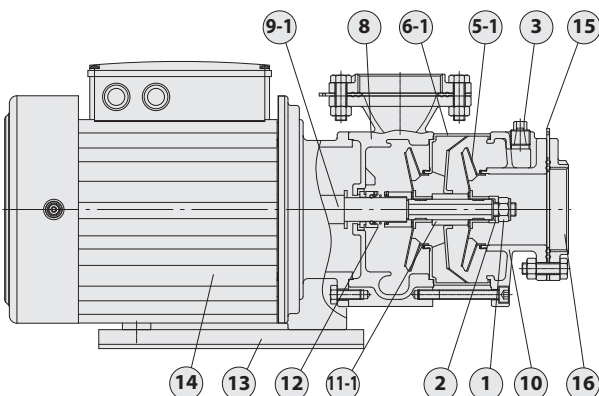

Materials

No.	Part name	Material		
		Standard	S series	N series
1	Lock Nut	SUS 316	SUS 316	SUS 316
2	Sleeve(Shaft End)	SUS 316	SUS 316	SUS 316
3	Water Plug	FC 20	SUS 304	SUS 316
4	O Ring	HNBR	HNBR	-
5	Impeller	SUS 304	SUS 304	-
5-1	Impeller	SUS 316	-	SUS316
6	Intermediate Chamber	SUS 304	SUS 304	-
6-1	Intermediate Chamber	SUS 316	-	SUS 316
7	Gasket	Teflon	Teflon	-
8	Pump Casing	FC 20	SUS 304	SUS 316
9	Shaft	SUS 304	SUS 304	-
9-1	Shaft	SUS 316	-	SUS 316
10	Suction Chamber	FC 20	SUS 304	SUS316
11	Sleeve	SUS 304	SUS 304	-
11-1	Sleeve	SUS 316	SUS 316	SUS 316
12	Mechanical Seal	HGSH		
13	Mounted Base	Coating Steel		
14	Motor Shell	Aluminum alloy		
15	Gasket	Teflon+NBR		
16	Flange	FC 20	-	SUS 316

SUS 304 may be replaced by SUS316 depended on stock availability.

Options on request

- Terminal box position adjustable
- Special mechanical seal

Mechanical seal type	Material	
	Stationary Face/ Rotary Face	Cup Gasket & O Ring
HGSH HGSV HGSE	(G)Carbon/ (S)Silicium carbide	(H) HNBR (V) Viton
HSSH HSSV HSSE	(S)Silicium carbide/ (S)Silicium carbide	(E) EPDM

TPH 2T

Electrical data, 50Hz

Model	PH (Ø)	voltage code	Cycle (Hz)	Volts (V)	Input Power (W)	Ampere (A)
TPH 2T 2K	1	51R	50	200-240	450	2.4
	3	53Q	50	200-240 / 380-440	420	2.0 / 1.3
TPH 2T 3K	1	51R	50	200-240	500	2.5
	3	53Q	50	200-240 / 380-440	520	2.2 / 1.4
TPH 2T 4K	1	51R	50	200-240	600	2.9
	3	53Q	50	200-240 / 380-440	590	2.3 / 1.4
TPH 2T 5K	1	51R	50	200-240	760	4.0
	3	53Q	50	200-240 / 380-440	680	3.0 / 1.9
TPH 2T 6K	1	51R	50	200-240	880	4.3
	3	53Q	50	200-240 / 380-440	860	3.1 / 2.0

Electrical data, 50/60Hz

Model	PH (Ø)	voltage code	Cycle (Hz)	Volts (V)	Input Power (W)	Ampere (A)
TPH 2T 1K	3	A3Z	50	200-255 / 380-440	340	1.6-2.8 / 1.0-1.5
			60	200-255 / 380-480	370	1.5-1.9 / 1.0-1.3
TPH 2T 2K	3	A3Z	50	200-255 / 380-440	450	1.9-2.8 / 1.2-1.5
			60	200-255 / 380-480	560	2.1-2.2 / 1.5-1.5
TPH 2T 3K	3	A3Z	50	200-255 / 380-440	530	2.0-2.8 / 1.3-1.6
			60	200-255 / 380-480	750	2.6-2.5 / 1.6-1.6
TPH 2T 4K	3	A3Z	50	200-255 / 380-440	620	2.2-2.9 / 1.4-1.7
			60	200-255 / 380-480	910	3.0-2.9 / 1.7-1.7
TPH 2T 5K	3	A3Z	50	200-255 / 380-440	700	2.4-3.0 / 1.4-1.6
			60	200-255 / 380-480	1060	3.3-3.0 / 1.8-1.8
TPH 2T 6K	3	A3Z	50	200-255 / 380-440	850	3.1-3.6 / 1.8-2.1
			60	200-255 / 380-480	1290	4.0-3.6 / 2.4-2.4

Electrical data, 60Hz

Model	PH (Ø)	voltage code	Cycle (Hz)	Volts (V)	Input Power (W)	Ampere (A)
TPH 2T 1K	1	61B	60	220	450	2.1
TPH 2T 2K	1	61B	60	220	760	4.3
TPH 2T 3K	1	61B	60	220	900	4.8
TPH 2T 4K	1	61B	60	220	1030	5.3
TPH 2T 5K	1	61B	60	220	1300	6.3
TPH 2T 6K	1	61B	60	220	1500	7.0

Model	PH (Ø)	voltage code	Cycle (Hz)	Volts (V)	Input Power (W)	Ampere (A)
TPH 2T 1K	1	61E	60	110/220	450	4.8/2.4
TPH 2T 2K	1	61E	60	110/220	570	6.0/3.0
TPH 2T 3K	1	61E	60	110/220	780	7.8/3.9
TPH 2T 4K	1	61E	60	110/220	900	9.0/4.5
TPH 2T 5K	1	61E	60	110/220	1080	12.0/6.0
TPH 2T 6K	1	61E	60	110/220	1420	14.0/7.0

Dimensions (mm)

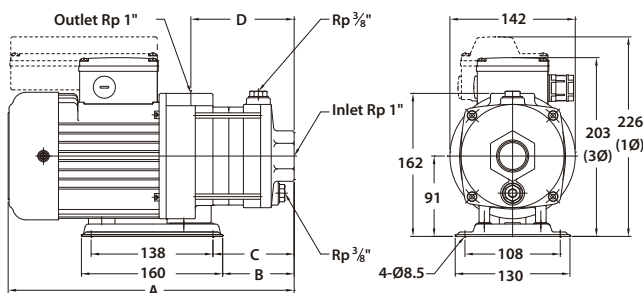

Model	A(mm)	B(mm)	C(mm)	D(mm)	N.W.(kg)	
TPH 2T 1K	306	63	74	99	11.7	36 pcs
TPH 2T 2K	306	63	74	99	11.8	
TPH 2T 3K	324	81	92	117	11.9	
TPH 2T 4K	342	99	110	135	12.0	
TPH 2T 5K	400	117	128	153	13.5	30 pcs
TPH 2T 6K	418	135	146	171	13.6	

Performance curve (50Hz)

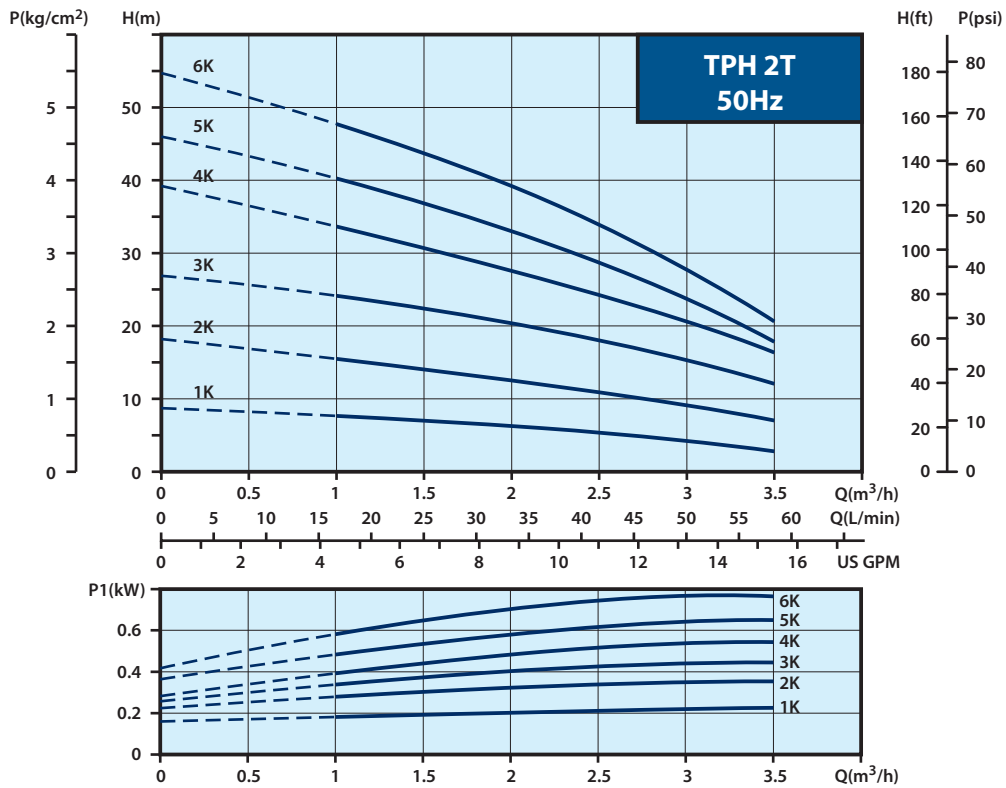

Performance curve (60Hz)

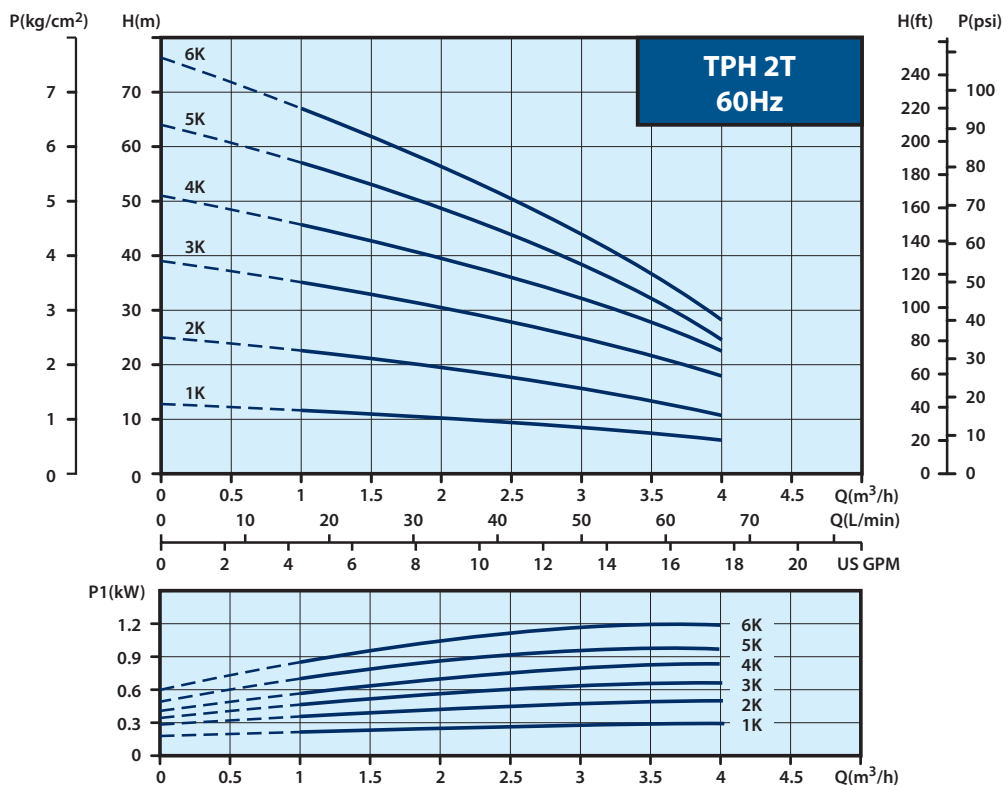

TPH 4T

Electrical data, 50Hz

Model	PH (Ø)	voltage code	Cycle (Hz)	Volts (V)	Input Power (W)	Ampere (A)
TPH 4T 2K	1	51R	50	200-240	600	3.1-2.9
	3	53Q	50	200-240 / 380-440	600	2.3 / 1.4
TPH 4T 3K	1	51R	50	200-240	950	4.5
	3	53Q	50	200-240 / 380-440	830	3.3 / 2.1
TPH 4T 4K	1	51R	50	200-240	1200	5.7
	3	53Q	50	200-240 / 380-440	1010	3.7 / 2.2
TPH 4T 5K	1	51R	50	200-240	1370	6.9
	3	53Q	50	200-240 / 380-440	1300	4.1 / 2.4
TPH 4T 6K	1	51R	50	200-240	1470	7.7
	3	53Q	50	200-240 / 380-440	1640	5.5 / 3.5

Electrical data, 50/60Hz

Model	PH (Ø)	voltage code	Cycle (Hz)	Volts (V)	Input Power (W)	Ampere (A)
TPH 4T 2K	3	A3Z	50	200-255 / 380-440	650	2.2-2.9 / 1.4-1.7
			60	200-255 / 380-480	960	3.0-2.7 / 1.7-1.7
TPH 4T 3K	3	A3Z	50	200-255 / 380-440	850	3.1-3.6 / 1.8-2.1
			60	200-255 / 380-480	1290	4.0-3.6 / 2.4-2.4
TPH 4T 4K	3	A3U	50	200-240 / 380-415	1080	3.4-3.5 / 2.0-2.0
			60	200-240 / 380-440	1620	4.5-5.0 / 2.9-2.9
TPH 4T 5K	3	A3U	50	200-240 / 380-415	1440	4.9-6.8 / 3.0-3.8
			60	200-240 / 380-440	2100	6.2-6.0 / 3.5-3.5
TPH 4T 6K	3	A3U	50	200-240 / 380-415	1740	6.3-9.9 / 4.2-5.5
			60	200-240 / 380-440	2400	7.7-7.6 / 4.5-4.5

Electrical data, 60Hz

Model	PH (Ø)	voltage code	Cycle (Hz)	Volts (V)	Input Power (W)	Ampere (A)
TPH 4T 2K	1	61B	60	220	1030	5.3
TPH 4T 3K	1	61B	60	220	1500	7.0
TPH 4T 4K	1	61B	60	220	1760	8.6
TPH 4T 5K	1	61B	60	220	2100	10.0
TPH 4T 6K	1	61B	60	220	2600	12.0

Model	PH (Ø)	voltage code	Cycle (Hz)	Volts (V)	Input Power (W)	Ampere (A)
TPH 4T 2K	1	61E	60	110/220	1030	10.4/5.3
TPH 4T 3K	1	61E	60	110/220	1500	14.8/7.4
TPH 4T 4K	1	61E	60	110/220	1760	17.2/8.6

Dimensions (mm)

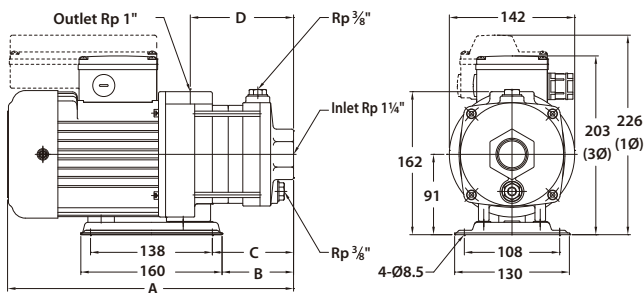

Model	Cycle (Hz)	A(mm)	B(mm)	C(mm)	D(mm)	N.W.(kg)	
TPH 4T 2K	50/60	315	72	83	108	11.7	36 pcs
TPH 4T 3K	50/60	382	99	110	135	13.3	
TPH 4T 4K	50/60	409	126	137	162	14.1	
TPH 4T 5K	50/60	436	153	164	189	14.2	
TPH 4T 6K	50	463	180	191	216	15.1	24 pcs
	60	494	180	191	216	16.1	

Performance curve (50Hz)

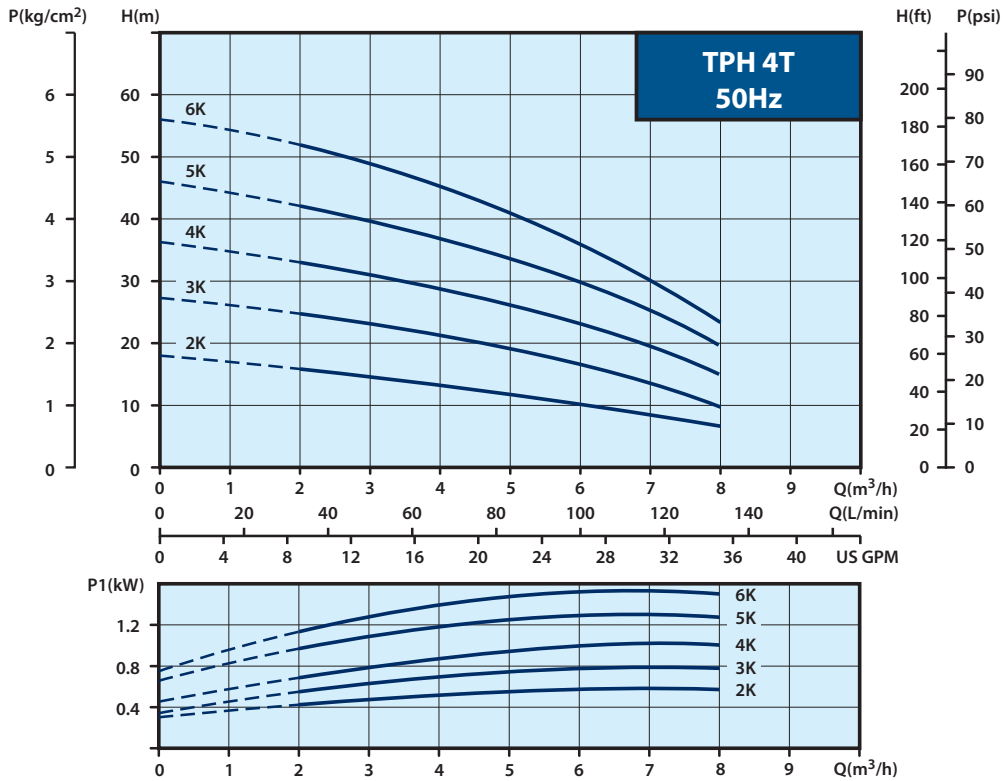

Performance curve (60Hz)

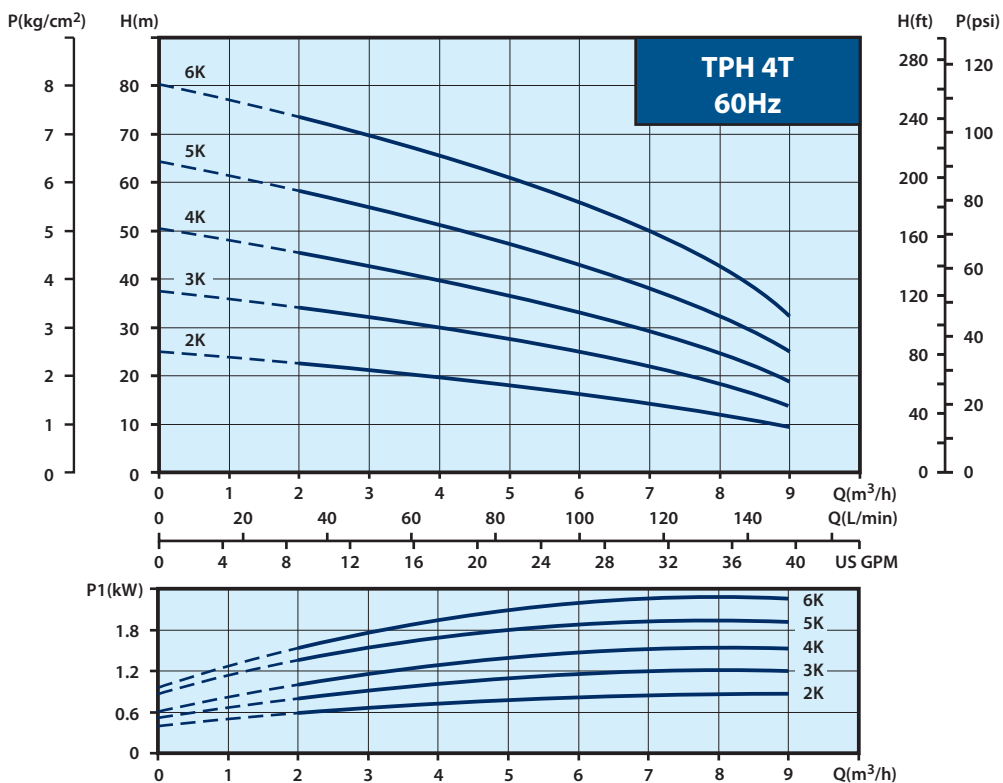

TPH 8T

Electrical data, 50Hz

Model	PH (Ø)	voltage code	Cycle (Hz)	Volts (V)	Input Power (W)	Ampere (A)
TPH 8T 2K	1	51R	50	200-240	900	4.3
	3	53Q	50	200-240 / 380-440	810	3.0 / 1.9
TPH 8T 3K	1	51R	50	200-240	1300	6.3
	3	53Q	50	200-240 / 380-440	1110	3.3 / 2.1
TPH 8T 4K	1	51R	50	200-240	1520	7.6
	3	53Q	50	200-240 / 380-440	1600	5.6 / 3.5
TPH 8T 5K	3	53Q	50	200-240 / 380-440	2000	6.0 / 3.6
TPH 8T 6K	3	53Q	50	200-240 / 380-440	2230	6.7 / 3.9

Electrical data, 50/60Hz

Model	PH (Ø)	voltage code	Cycle (Hz)	Volts (V)	Input Power (W)	Ampere (A)
TPH 8T 2K	3	A3Z	50	200-255 / 380-440	850	3.1-3.6 / 1.8-2.1
			60	200-255 / 380-480	1290	4.0-3.6 / 2.4-2.4
TPH 8T 2.5K	3	A3U	50	200-240 / 380-415	980	3.1-3.3 / 1.8-2.0
			60	200-240 / 380-440	1460	4.4-4.1 / 2.4-2.4
TPH 8T 3K	3	A3U	50	200-240 / 380-415	1400	4.9-6.8 / 3.0-3.8
			60	200-240 / 380-440	2100	6.2-6.0 / 3.5-3.5
TPH 8T 4K	3	A3U	50	200-240 / 380-415	1780	5.5-8.7 / 3.8-4.9
			60	200-240 / 380-440	2460	7.9-7.2 / 4.4-4.4
TPH 8T 5K	3	A3U	50	200-240 / 380-415	2000	5.9-8.5 / 3.8-5.0
			60	200-240 / 380-440	2700	8.1-7.8 / 4.6-4.6

Electrical data, 60Hz

Model	PH (Ø)	voltage code	Cycle (Hz)	Volts (V)	Input Power (W)	Ampere (A)
TPH 8T 2K	1	61B	60	220	1500	7.0
TPH 8T 2.5K	1	61B	60	220	1720	8.7
TPH 8T 3K	1	61B	60	220	1970	10.0

Model	PH (Ø)	voltage code	Cycle (Hz)	Volts (V)	Input Power (W)	Ampere (A)
TPH 8T 2K	1	61E	60	110/220	1330	14.0/7.0
TPH 8T 2.5K	1	61E	60	110/220	1600	15.0/7.5
TPH 8T 3K	1	61E	60	110/220	2000	19.4/9.7

Dimensions (mm)

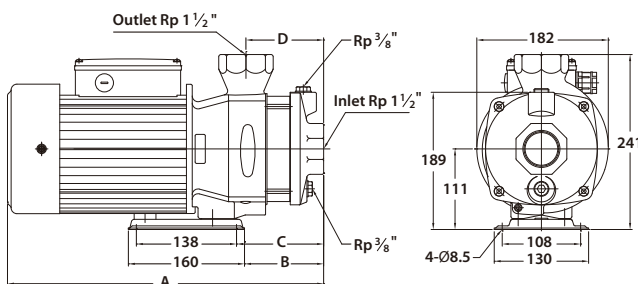

Model	Cycle (Hz)	A(mm)	B(mm)	C(mm)	D(mm)	N.W.(kg)	
TPH 8T 2K	50/60	376.5	77	88	75	18.8	24 pcs
TPH 8T 2.5 K	60	408.5	109	120	107	19.5	
TPH 8T 3K	50/60	408.5	109	120	107	20.0	
TPH 8T 4K	50	408.5	109	120	107	22.2	
	60	435.5	109	120	107	25.4	
TPH 8T 5K	50/60	469.5	143	154	141	25.5	
TPH 8T 6K	50	469.5	143	154	141	25.5	

Performance curve (50Hz)

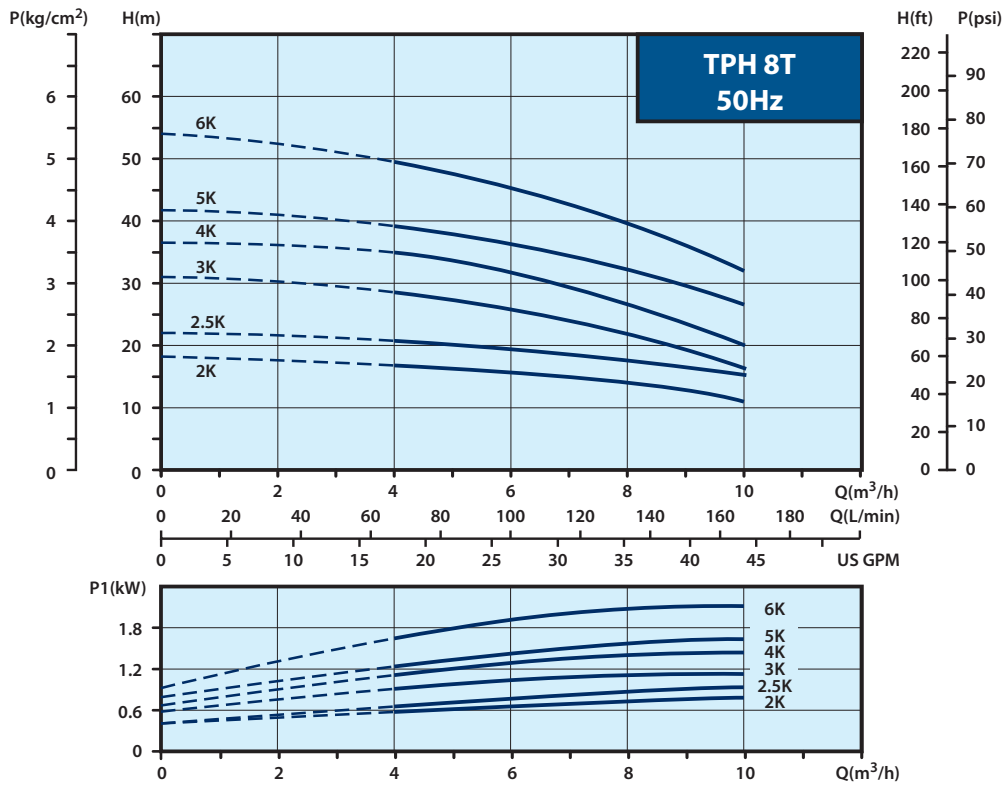

Performance curve (60Hz)

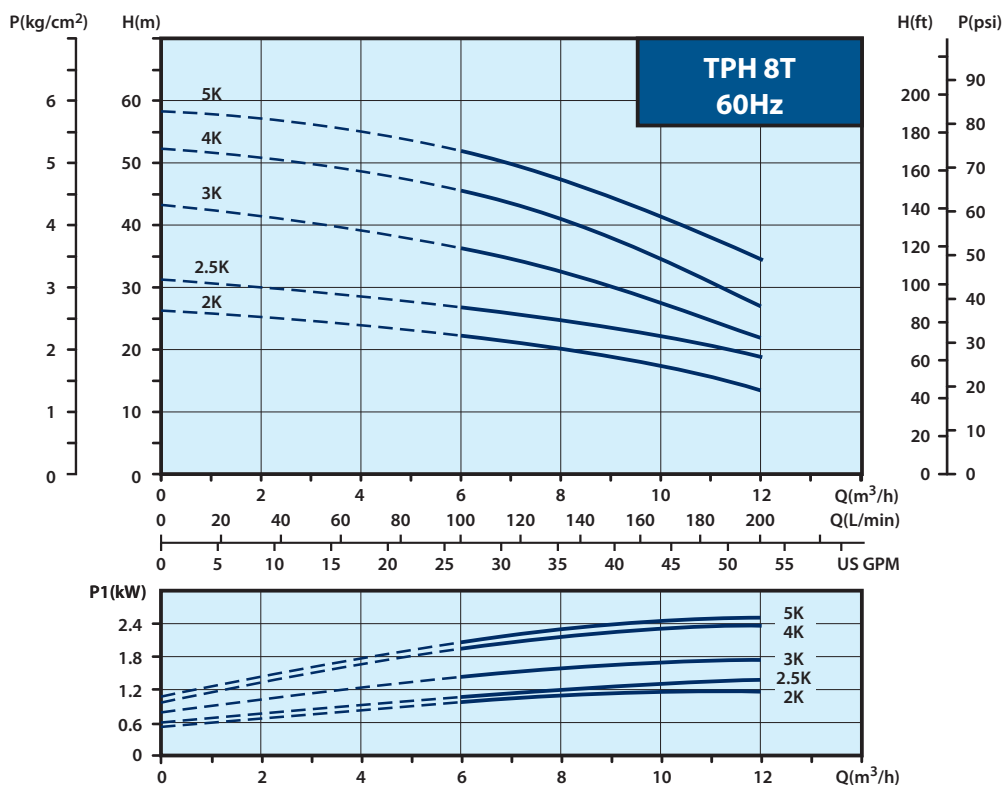

TPH 12T

Electrical data, 50Hz

Model	PH (Ø)	voltage code	Cycle (Hz)	Volts (V)	Input Power (W)	Ampere (A)
TPH 12T 2K	1	51R	50	200-240	1380	6.5
	3	53Q	50	200-240 / 380-440	1140	3.6 / 2.1
TPH 12T 3K	1	51R	50	200-240	1700	7.9
	3	53Q	50	200-240 / 380-440	1580	5.8 / 3.6
TPH 12T 4K	3	53Q	50	200-240 / 380-440	2500	7.1 / 4.1
TPH 12T 5K	3	53Q	50	200-240 / 380-440	3050	10.8 / 6.8
TPH 12T 6K	3	53Q	50	200-240 / 380-440	3700	11.3 / 7.0

Electrical data, 50/60Hz

Model	PH (Ø)	voltage code	Cycle (Hz)	Volts (V)	Input Power (W)	Ampere (A)
TPH 12T 1K	3	A3Z	50	200-255 / 380-440	600	2.2-2.9 / 1.4-1.7
			60	200-255 / 380-480	860	2.6-2.6 / 1.7-1.7
TPH 12T 2K	3	A3U	50	200-240 / 380-415	1500	4.9-6.8 / 3.0-3.8
			60	200-240 / 380-440	2200	6.2-6.0 / 3.5-3.5
TPH 12T 3K	3	A3U	50	200-240 / 380-415	2000	6.2-8.8 / 3.9-5.0
			60	200-240 / 380-440	2900	8.8-8.0 / 4.9-4.9
TPH 12T 4K	3	A3U	50	200-240 / 380-415	2900	9.0-13.1 / 5.8-7.9
			60	200-240 / 380-440	4100	12.4-11.2 / 6.7-6.7

Electrical data, 60Hz

Model	PH (Ø)	voltage code	Cycle (Hz)	Volts (V)	Input Power (W)	Ampere (A)
TPH 12T 1K	1	61B	60	220	1030	5.3
TPH 12T 2K	1	61B	60	220	2200	11.2

Model	PH (Ø)	voltage code	Cycle (Hz)	Volts (V)	Input Power (W)	Ampere (A)
TPH 12T 1K	1	61E	60	110/220	950	9.0 / 4.5

Dimensions (mm)

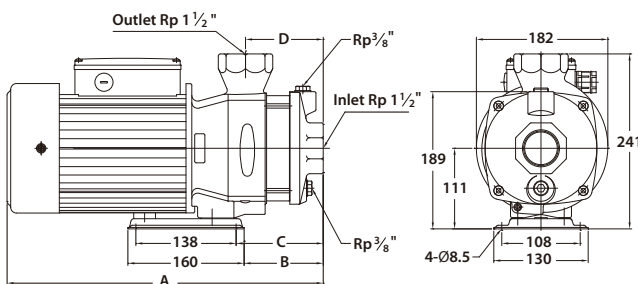

Model	Cycle (Hz)	A(mm)	B(mm)	C(mm)	D(mm)	N.W.(kg)	
TPH 12T 1K	50/60	336.5	77	88	75	17.6	24 pcs
TPH 12T 2K	50/60	376.5	77	88	75	20.0	
TPH 12T 3K	50	408.5	109	120	107	22.0	
	60	435.5	109	120	107	25.4	
TPH 12T 4K	50/60	435.5	109	120	107	28.0	
TPH 12T 5K	50	469.5	143	154	141	29.2	
TPH 12T 6K	50	469.5	143	154	141	29.2	

Performance curve (50Hz)

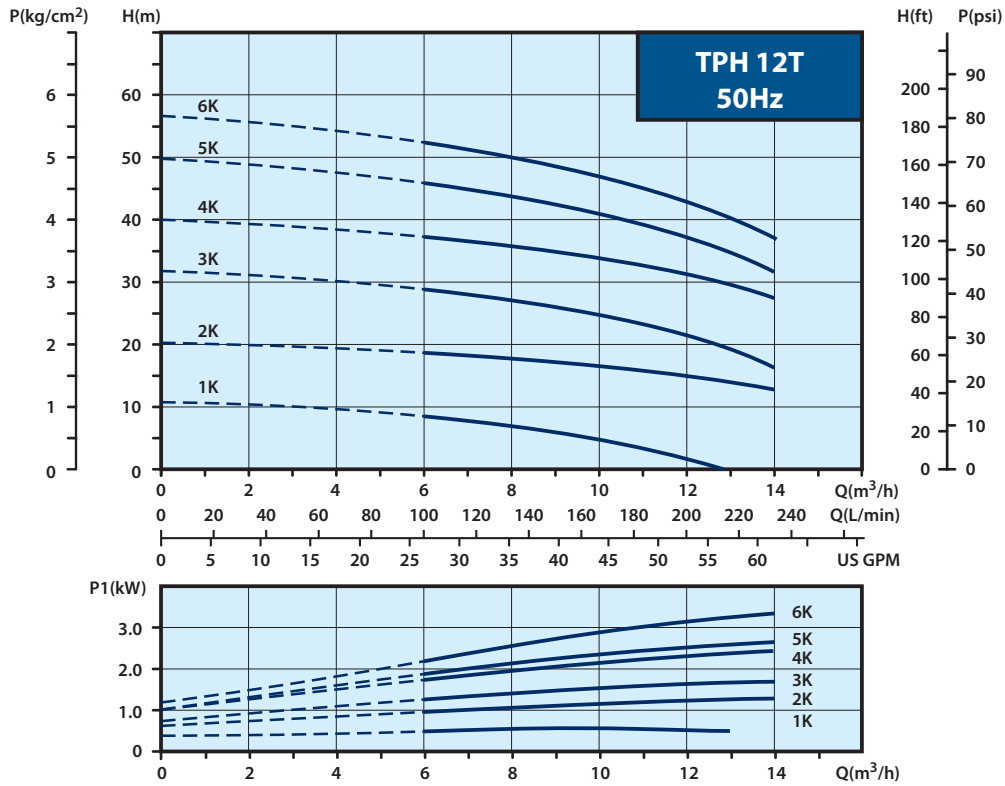

Performance curve (60Hz)

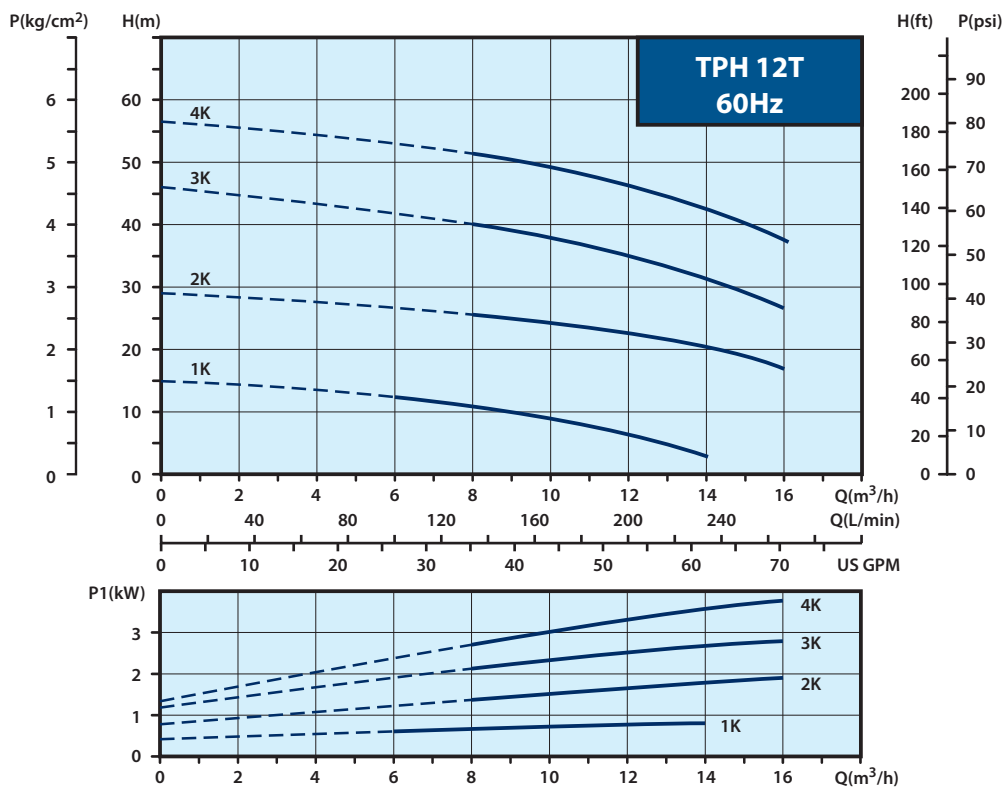

TPH 25T

Electrical data, 50Hz

Model	PH (Ø)	voltage code	Cycle (Hz)	Volts (V)	Input Power (W)	Ampere (A)
TPH 25T 2KF	3	53Q	50	200-240 / 380-440	4000	12.0 / 6.5
TPH 25T 3KF	3	53Q	50	200-240 / 380-440	4800	15.6 / 10.0
TPH 25T 4KF	3	53Q	50	200-240 / 380-440	5700	18.0 / 11.3
TPH 25T 5KF	3	53Q	50	200-240 / 380-440	7800	24.1 / 13.9

Dimensions (mm), 50Hz

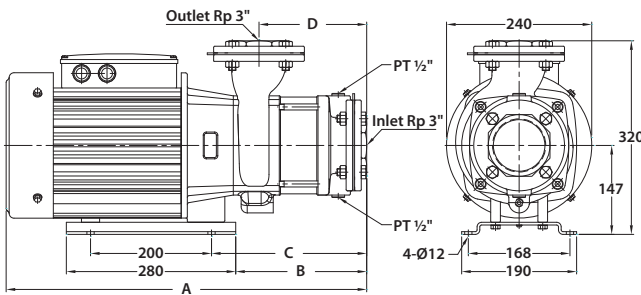

Model	A(mm)	B(mm)	C(mm)	D(mm)	N.W.(kg)
TPH 25T2KF	596	216.5	256.5	178	53.0
TPH 25T3KF	656	276.5	316.5	238	58.8
TPH 25T4KF	656	276.5	316.5	238	59.0
TPH 25T5KF	766	336.5	376.5	298	71.0

Electrical data, 60Hz

Model	PH (Ø)	voltage code	Cycle (Hz)	Volts (V)	Input Power (W)	Ampere (A)
TPH 25T 2KF	3	63Z	60	200-255 / 380-480	4000	12.9-10.5 / 7.3-5.8
TPH 25T 3KF	3	63Z	60	200-255 / 380-480	5100	15.6-13.1 / 8.7-8.2
TPH 25T 4KF	3	63Z	60	200-255 / 380-480	7200	21.2-20.5 / 12.3-12.5
TPH 25T 5KF	3	63Z	60	200-255 / 380-480	8000	25.6-22.4 / 13.7-13.2
TPH 25T 6KF	3	63Z	60	200-255 / 380-480	10200	31.2-27.5 / 17.5-15.8

Dimensions (mm), 60Hz

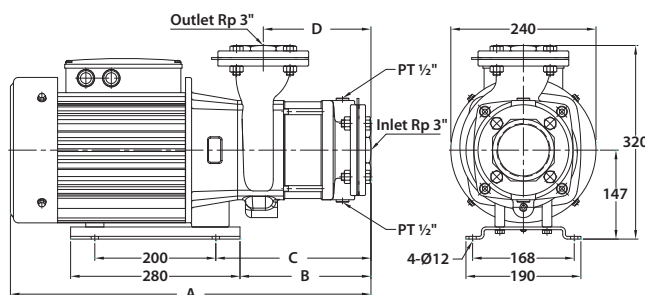

Model	A(mm)	B(mm)	C(mm)	D(mm)	N.W.(kg)
TPH 25T2KF	536	156.5	196.5	118	51.0
TPH 25T3KF	596	216.5	256.5	178	56.8
TPH 25T4KF	596	216.5	256.5	178	57.0
TPH 25T5KF	706	276.5	316.5	238	68.8
TPH 25T6KF	706	276.5	316.5	238	69.0

Performance curve (50Hz)

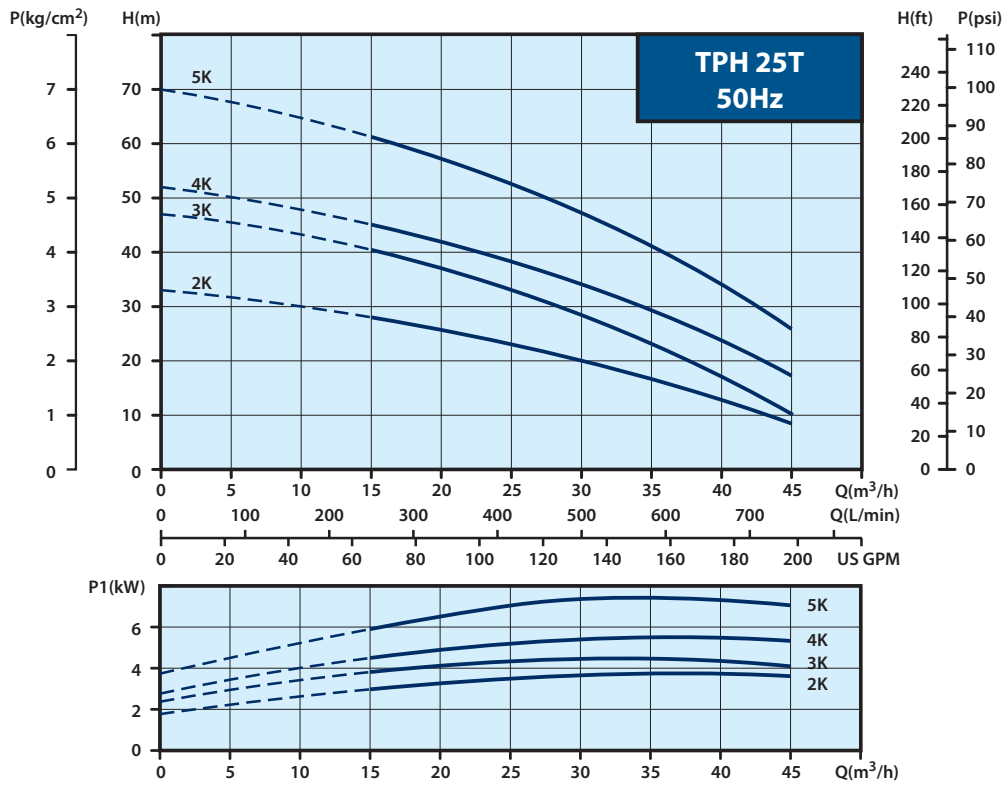

Performance curve (60Hz)

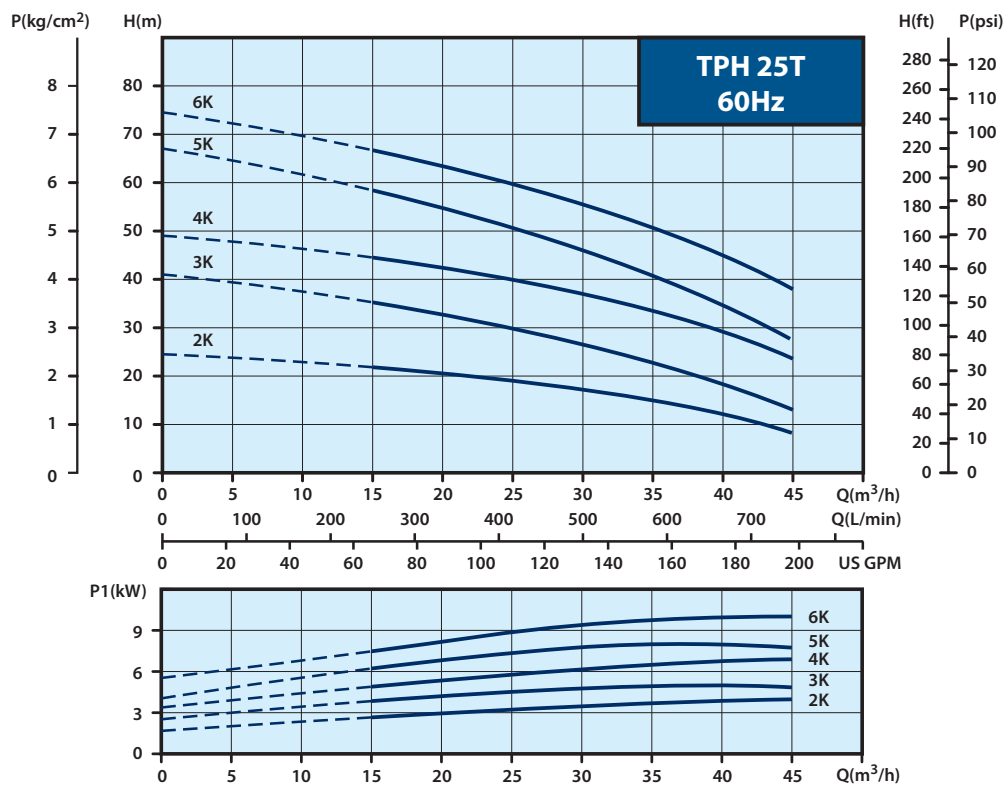

TPH 50T

Electrical data, 50Hz

Model	PH (Ø)	voltage code	Cycle (Hz)	Volts (V)	Input Power (W)	Ampere (A)
TPH 50 T 2 KF	3	53Q	50	200-240 / 380-440	6600	20.3-19.2 / 11.2-12.9
TPH 50 T 3 KF	3	53Q	50	200-240 / 380-440	8700	26.0-22.6 / 14.4-14.8
TPH 50 T 4 KF	3	53Q	50	200-240 / 380-440	11600	36.3-30.8 / 19.8-20.4

Dimensions (mm), 50Hz

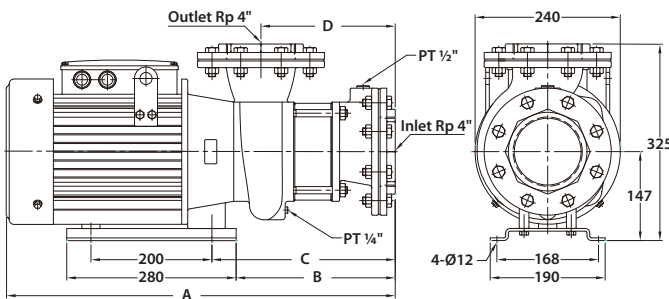

Model	A(mm)	B(mm)	C(mm)	D(mm)	N.W.(kg)
TPH 50T 2KF	642.5	263	303	222	61.5
TPH 50T 3KF	752.5	323	363	282	80.6
TPH 50T 4KF	802.5	323	363	282	88.0

Electrical data, 60Hz

Model	PH (Ø)	voltage code	Cycle (Hz)	Volts (V)	Input Power (W)	Ampere (A)
TPH 50T2.5KF	3	63Q	60	200-240 / 380-440	8500	25.0-23.3 / 14.1-14.8
TPH 50 T 4 KF	3	63Z	60	200-255 / 380-480	11500	34.8-32.2 / 19.1-21.7
TPH 50 T 5 KF	3	63Q	60	200-240 / 380-440	14200	44.3-42.6 / 23.9-26.3

Dimensions (mm), 60Hz

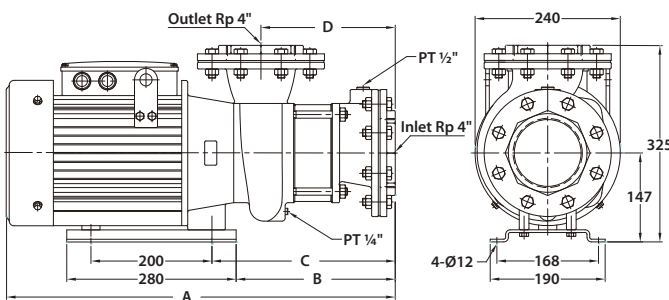

Model	A(mm)	B(mm)	C(mm)	D(mm)	N.W.(kg)
TPH 50T2.5KF	582.5	203	243	162	55.6
TPH 50T 4KF	692.5	263	303	222	77.6
TPH 50T 5KF	742.5	263	303	222	86.7

Performance curve (50Hz)

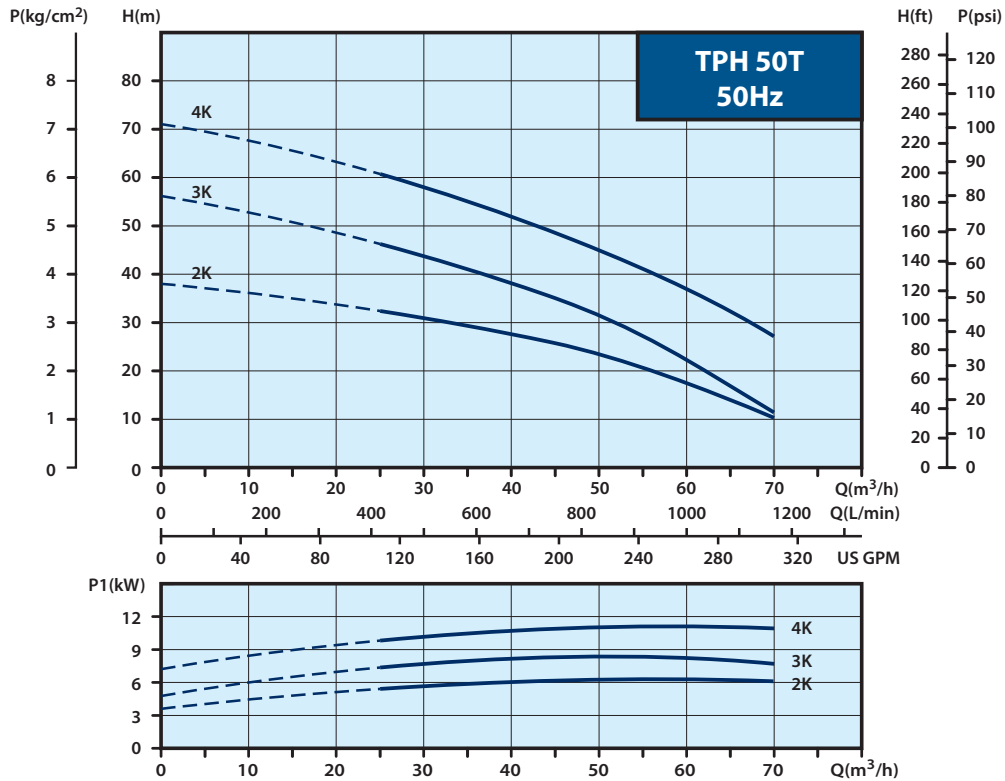

Performance curve (60Hz)

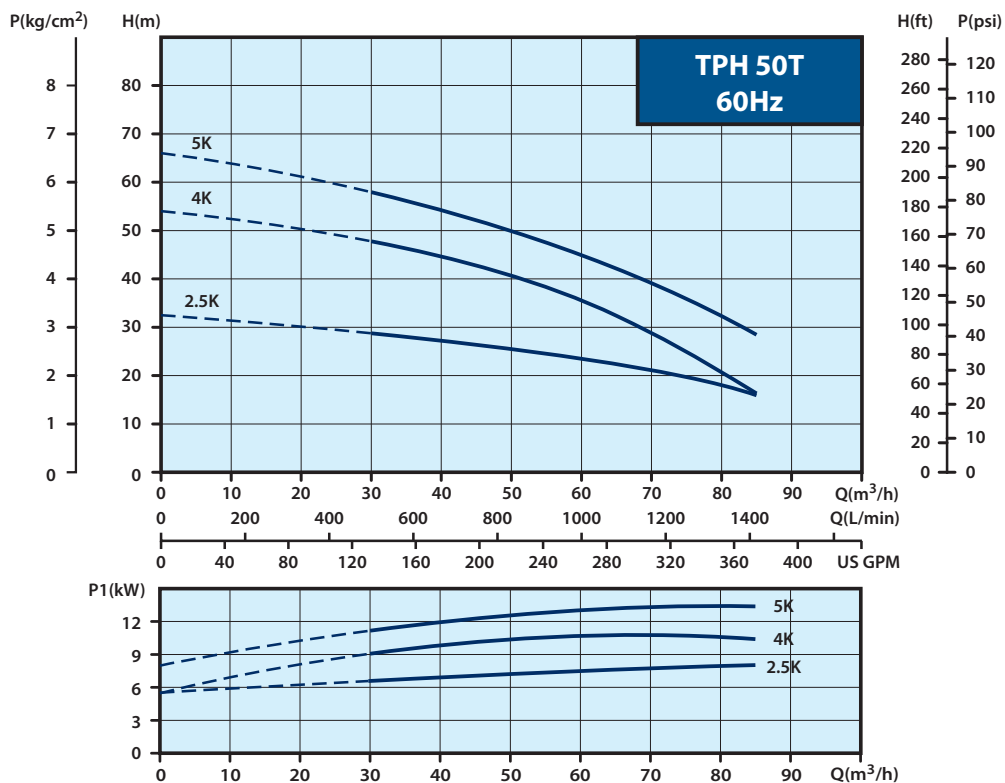



Memo





WALRUS
www.walruspump.com